

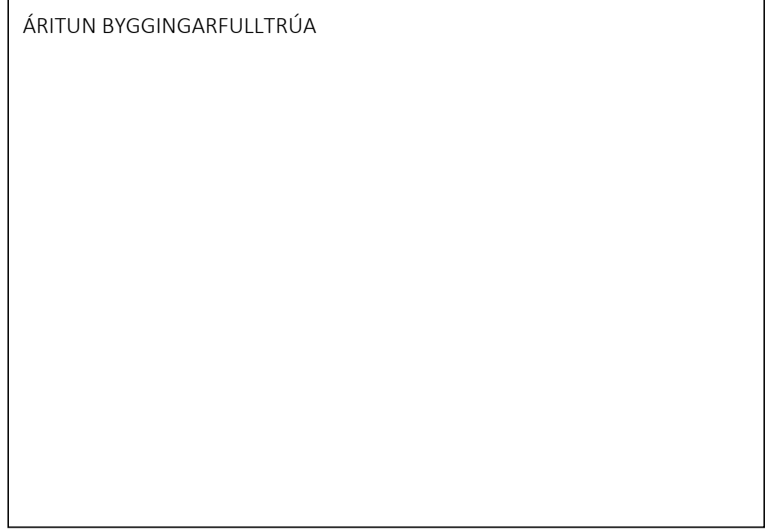

FRAMHÁLD EKKI HILTI AF ÞESSUM VERKÁFANGA

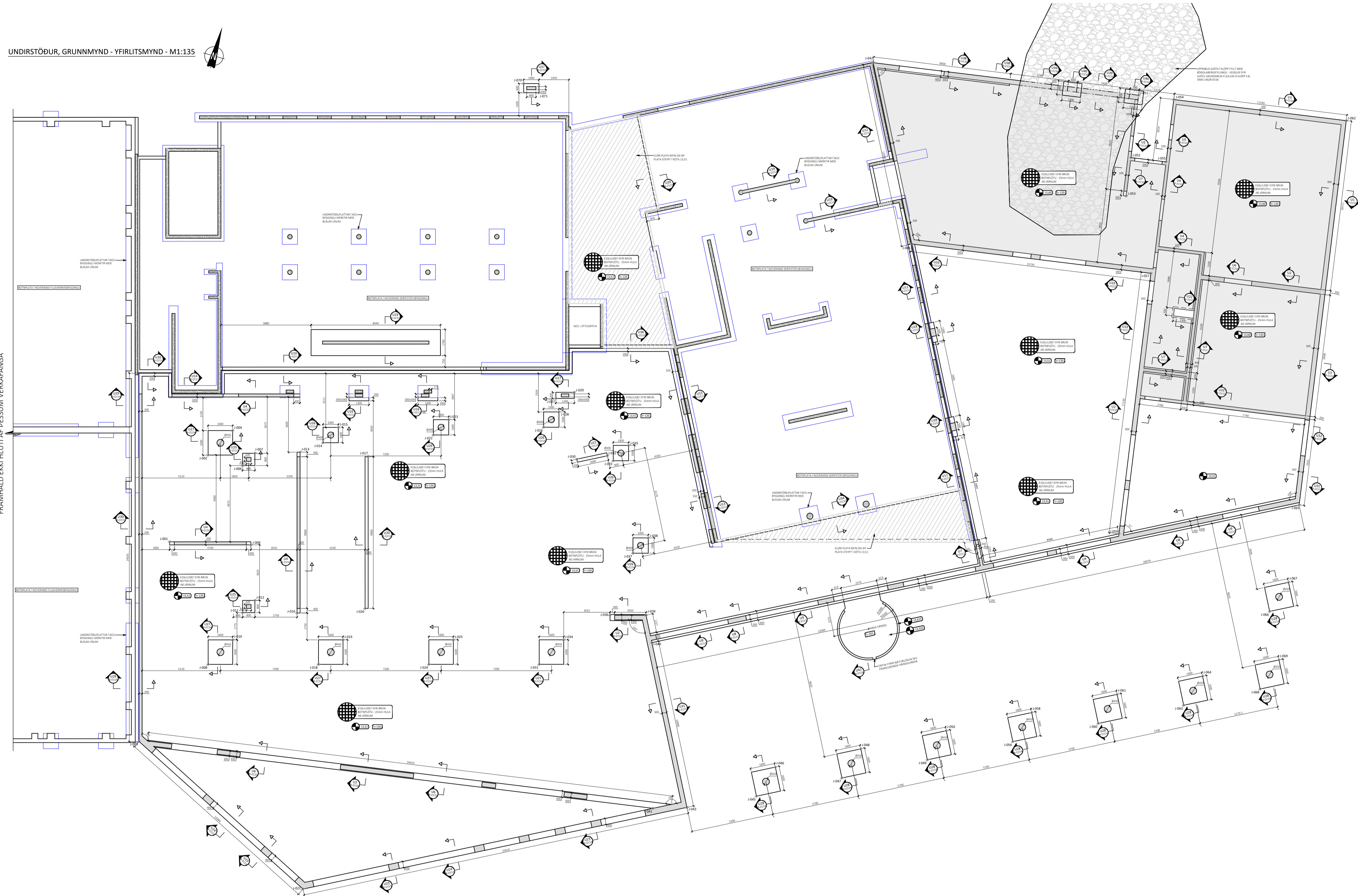

ÁRITUN HÖNNUNARSTJÓRA KT:
BYGGT Á ADALUPPRÁTTUM DAGSETTUM: 01.09.2022

- ALMENNAR SKÝRINGAR:
- SJÁ FLEIRI ALMENNAR SKÝRINGAR Á TEIKNINGU B-000
 - ÖLL MÁL ERU Í MILLIMETURM, EN KÓTAR OG HNIT ERU Í METURM
 - BYGGINGIN ER GRUNDUÐ Á KLÖPP
 - LEYFLEGT ÁLAG Á KLÖPP ER 2,0 MPa Í BROTMARKA-ÁSTANDI OG 3,0 MPa Í JARÐSKJÁLFTA
 - SJÁ TEIKNINGAR FRÁ VERKHÖNNUN FYRIR SÖKKULSKAUT
 - SJÁ TEIKNINGAR FRÁ FERLI FYRIR GÖT Í SÖKKLA OG STADSETNINGU GÖLFNIDURFALLA

- TÁKN:
- STADSTEYPA
 - FORSTEYPTAR EININGAR
 - NÜVERANDI STEYPA
 - U-XXX HNITAPUNKTUR FYRIR UNDIRSTÖÐU
 - 0,000 STEYPUKÓTI OFAN Á PLOTU
 - 120 PYKKT Á STEYPTRI BOTNPLOTU

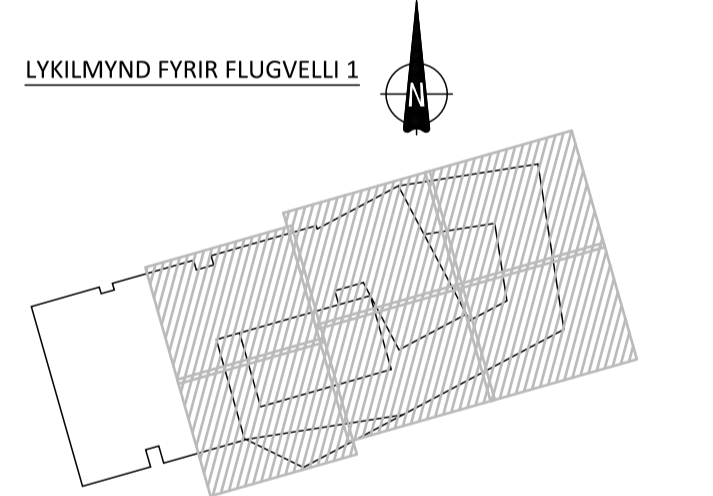

HNIT FYRIR UNDIRSTÖÐUR		HNIT FYRIR UNDIRSTÖÐUR		HNIT FYRIR UNDIRSTÖÐUR		HNIT FYRIR UNDIRSTÖÐUR		
X-HNIT	Y-HNIT	X-HNIT	Y-HNIT	X-HNIT	Y-HNIT	X-HNIT	Y-HNIT	
J-001	354149,484	397702,729	J-021	354164,068	397683,326	J-041	354184,582	397694,655
J-002	354150,344	397708,861	J-022	354164,120	397714,154	J-042	354185,050	397745,389
J-003	354151,138	397689,651	J-023	354164,808	397715,390	J-043	354186,694	397695,323
J-004	354151,444	397710,838	J-024	354167,941	397699,678	J-044	354190,717	397734,699
J-006	354152,696	397708,820	J-025	354169,040	397701,656	J-045	354190,857	397697,270
J-007	354153,246	397709,808	J-026	354170,896	397716,611	J-046	354191,521	397699,433
J-008	354154,094	397695,725	J-027	354171,149	397718,638	J-047	354195,893	397699,940
J-009	354154,636	397703,992	J-028	354171,583	397717,847	J-048	354196,557	397702,103
J-010	354155,193	397697,703	J-029	354172,194	397719,352	J-049	354200,929	397702,610
J-011	354155,331	397699,588	J-030	354173,551	397715,202	J-050	354201,593	397704,773
J-012	354155,881	397700,577	J-031	354174,864	397701,655	J-051	354202,287	397748,098
J-013	354156,062	397710,690	J-032	354175,411	397715,962	J-052	354202,923	397744,048
J-014	354157,335	397711,693	J-033	354175,868	397715,757	J-053	354203,316	397741,554
J-015	354158,022	397712,929	J-034	354175,964	397703,633	J-054	354204,569	397748,457
J-016	354158,752	397700,539	J-035	354176,555	397716,993	J-055	354205,205	397744,407
J-017	354160,413	397711,621	J-036	354178,431	397706,001	J-056	354205,965	397705,280
J-018	354161,018	397697,702	J-037	354178,758	397710,305	J-057	354206,246	397737,140
J-019	354162,117	397699,680	J-038	354179,445	397711,542	J-058	354206,629	397707,443
J-020	354162,939	397702,046	J-039	354180,690	397706,646	J-059	354208,906	397720,218
			J-040	354181,546	397705,032	J-060	354211,001	397707,950

B 03.01.2024 UNDIRSTÖÐU FYRIR HRINGHURD BÆTT VÍÐ
A 15.10.2022 SJÁ SKÝ
ÚTG. DAGS. SKÝRING

FLUGVELLIR 1 ICELANDAIR
HAFNARFIRDI

BURÐARVIRKI UNDIRSTÖÐUR GRUNNMYND - YFIRLITSMYND

SAMPYKKT: KENNITALA:
Handwritten signature 070970-4149

DAGS. ÚTGÁFU: 06.10.2022 HÖNNUNUR: HE
DAGS. BREYTT: 03.01.2024 YFIRFARID AF: GÖS

MELUKVÁRDI: 1:135

HANNA 21024 **B-0100** B
VERKFRÆÐISTOFA VERKNR. NÚMER ÚTG.
SUBURHRAUNI 10 210 GARDABÆR KT. 631216-0480
hannaverk.is hrund@hannaverk.is SÍMI: 771-5252

ÁRITUN BYGGINGARFULLTRÚA



Sampykkt
Hafnarfjörður
Byggingarfulltrúi

ÁRITUN HÖNNUNARSTJÓRA KT:
BYGGT Á ADALUPPRÁTTUM DAGSETTUM: 01.09.2022

- ALMENNAR SKÝRINGAR:
- SJÁ FLEIRI ALMENNAR SKÝRINGAR Á TEIKNINGU B-0000
 - ÖLL MÁL ERU Í MILLIMETURM, EN KÓTAR OG HNIT ERU Í METURM
 - BYGGINGIN ER GRUNDUÐ Á KLÖPP
 - LEYFILEGT ÁLAG Á KLÖPP ER 2,0 MPa Í BROTMARKA-ÁSTANDI OG 3,0 MPa Í JARÐSKJÁLFTA
 - SJÁ TEIKNINGAR FRÁ VERKHÖNNUN FYRIR SÖKKULSKAUT
 - SJÁ TEIKNINGAR FRÁ FERLI FYRIR GÖT Í SÖKKLA OG STAÐSETNINGU GÖLFNIÐURFALLA

- TÁKN:
- STADSTEYPA
 - FORSTEYPTAR EININGAR
 - NÚVERANDI STEYPA
 - U-XXX HNITAPUNKTUR FYRIR UNDIRSTÖÐU
 - 0,000 STEYPUKÓTI OFAN Á PLÖTU
 - t=120 PYKKT Á STEYPTRI BOTNPLÖTU

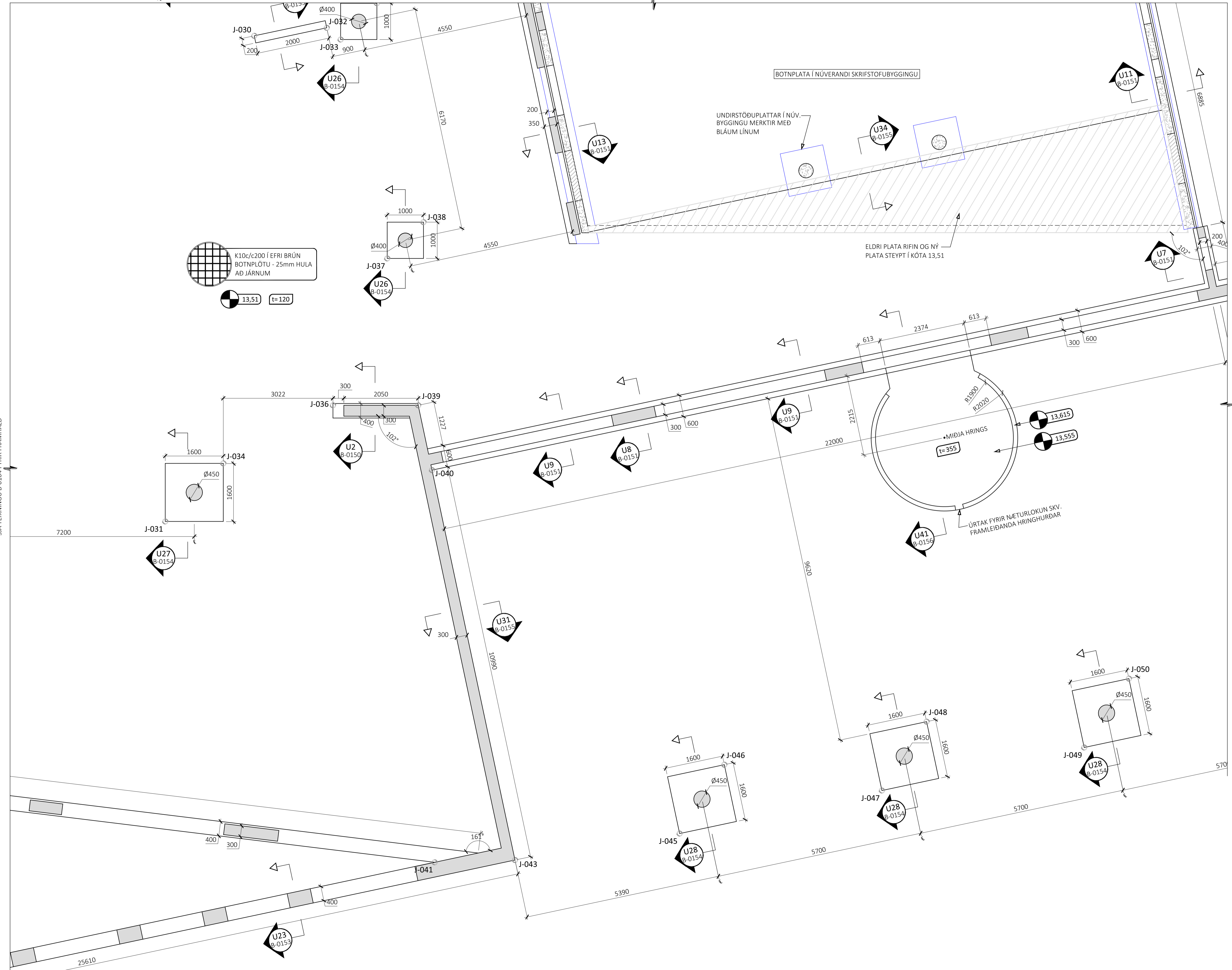

SJÁ TEIKNINGU B-0106 FYRIR FRAMHALD

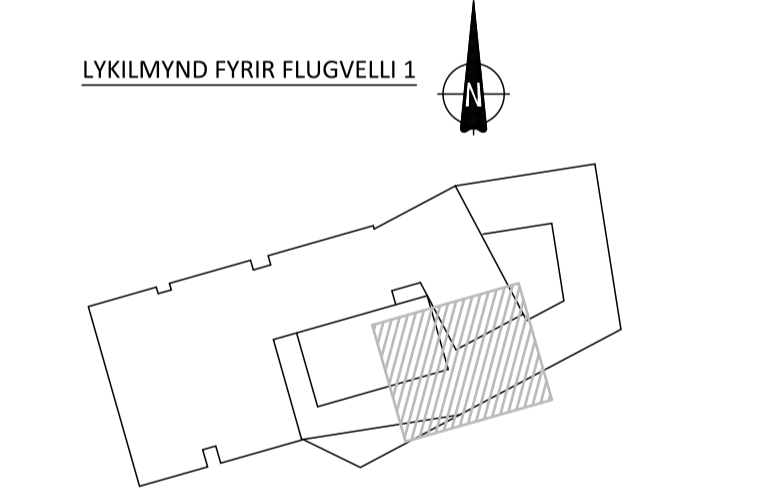

A 03.01.2024 UNDIRSTÖÐU FYRIR HRINGHURÐ BÆTT VID
ÚTG. DAGS. SKÝRING

FLUGVELLIR 1 ICELANDAIR
HAFNARFIRÐI

BURÐARVIRKI UNDIRSTÖÐUR GRUNNMYND - HLUÐI 5

SAMPYKKT: KENNITALA:
Hrund Dinsardóttir 070970-4149

DAGS. ÚTGÁFU: 06.10.2022 HÖNNUÐUR: HE
DAGS. BREYTT: 03.01.2024 YFIRFARID AF: GÖS

MÆLIKVARDI: 1:50



HANNA 21024 B-0105 A
VERKFRÆÐISTOFA VERKNR. NÚMER ÚTG.
SUBURHRAUNI 10 210 GARDABÆR KT. 631216-0480
hannaVerk.is hrund@hannaverk.is SÍMI: 771-5252

U20
M1:10

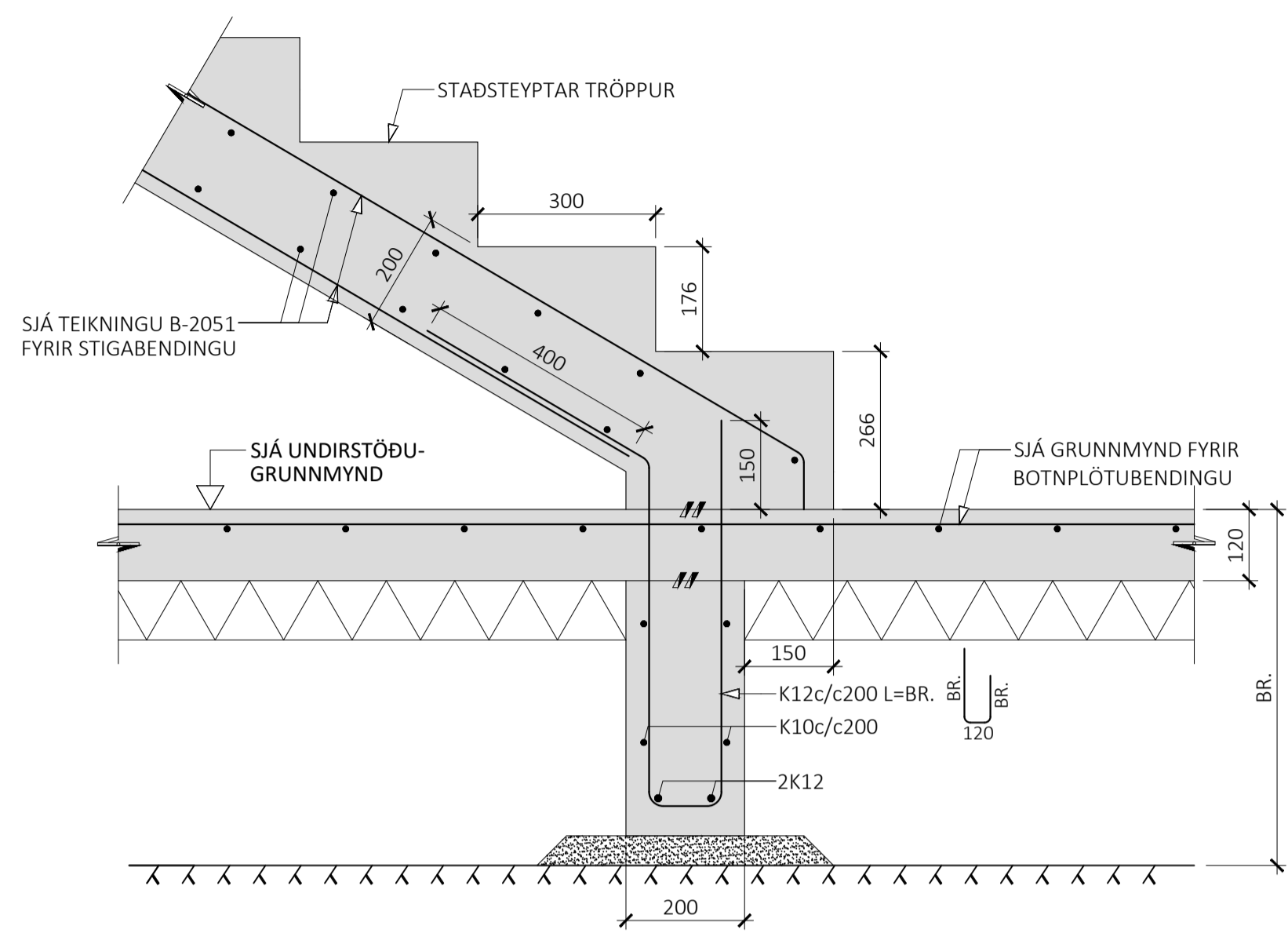

U21
M1:10

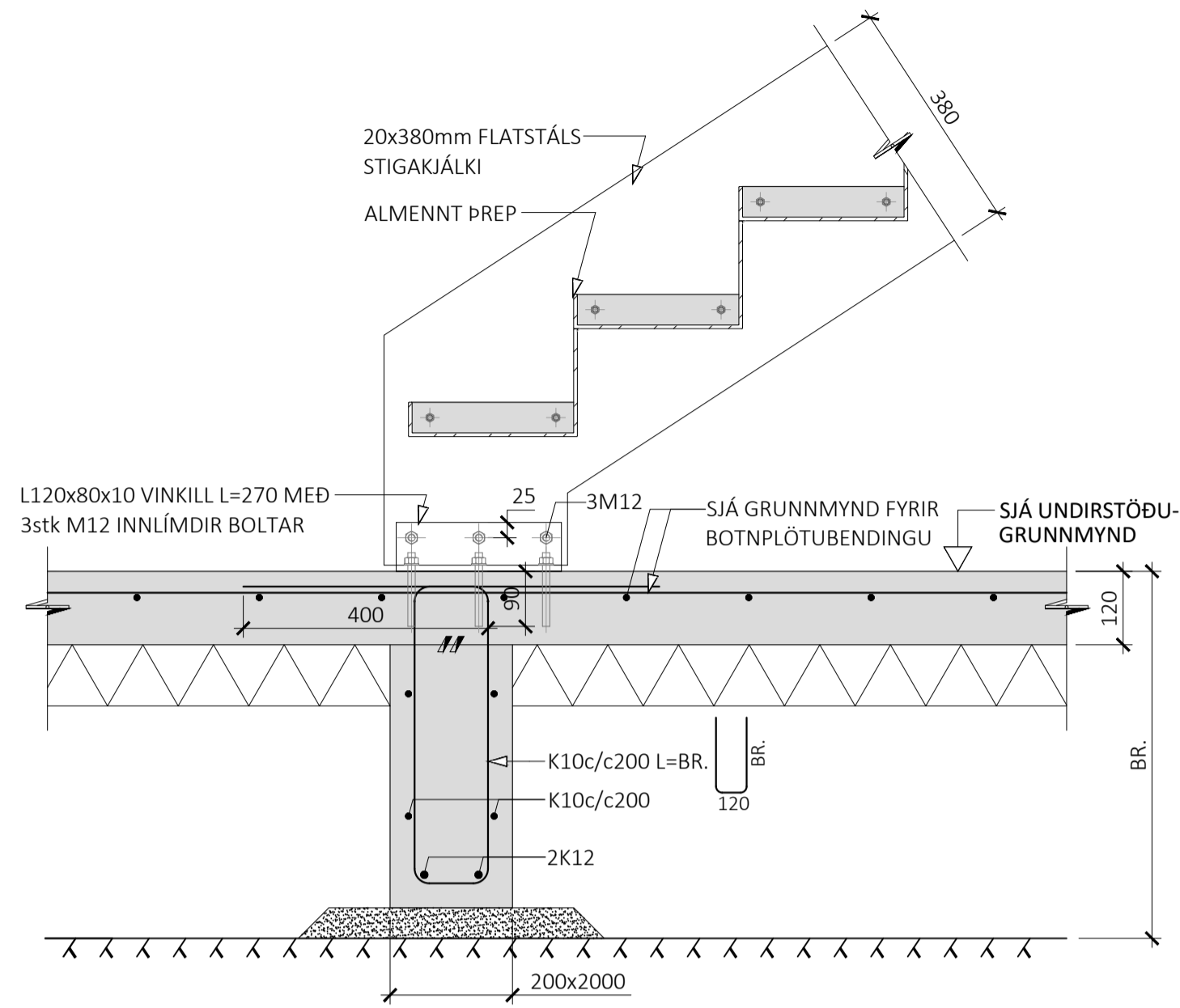

U22
M1:10

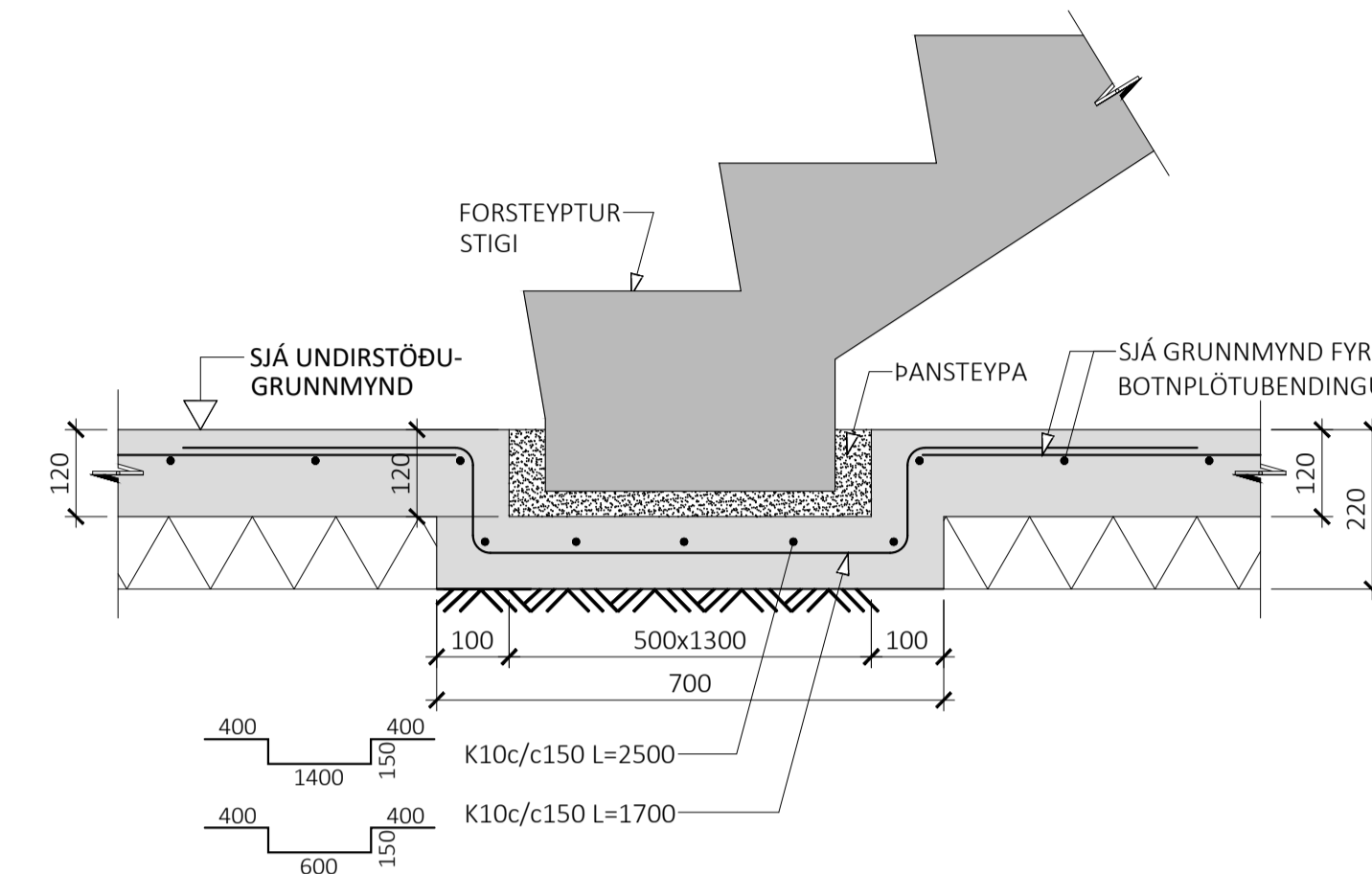

ÁRITUN BYGGINGARFULLTRÚA



Sampykkt
Hafnarfjörður
Byggingarfulltrúi

ÁRITUN HÖNNUNARSTJÓRA KT:
BYGGT Á ADALUPPRÁTTUM DAGSETTUM: 01.09.2022

ALMENNAR SKÝRINGAR:
• SJÁ FLEIRI ALMENNAR SKÝRINGAR Á TEIKNINGU B-0000
• ÖLL MÁL ERU Í MILLIMETURM, EN KÓTAR OG HNIT ERU Í METURM

TÁKN:

- STADSTEYPA
- FORSTEYPTAR EINANGAR
- NÚVERANDI STEYPA
- 100mm ÞYKK EINANGRUN MED RÚMPYNGD ≥ 24 kg/m³
- ÞJAPPADUR BÖGGLABERGSPÚDI
- KLÓPP

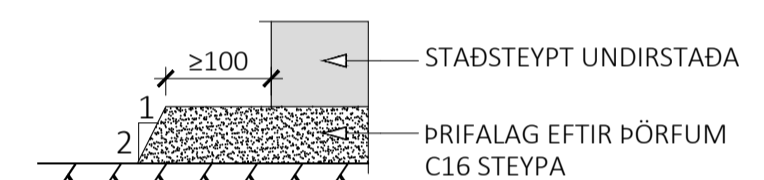

STADSTEYPT UNDIRSTADA
PRIFALAG EFTIR ÞÖRFUM C16 STEYPA

U23
M1:10

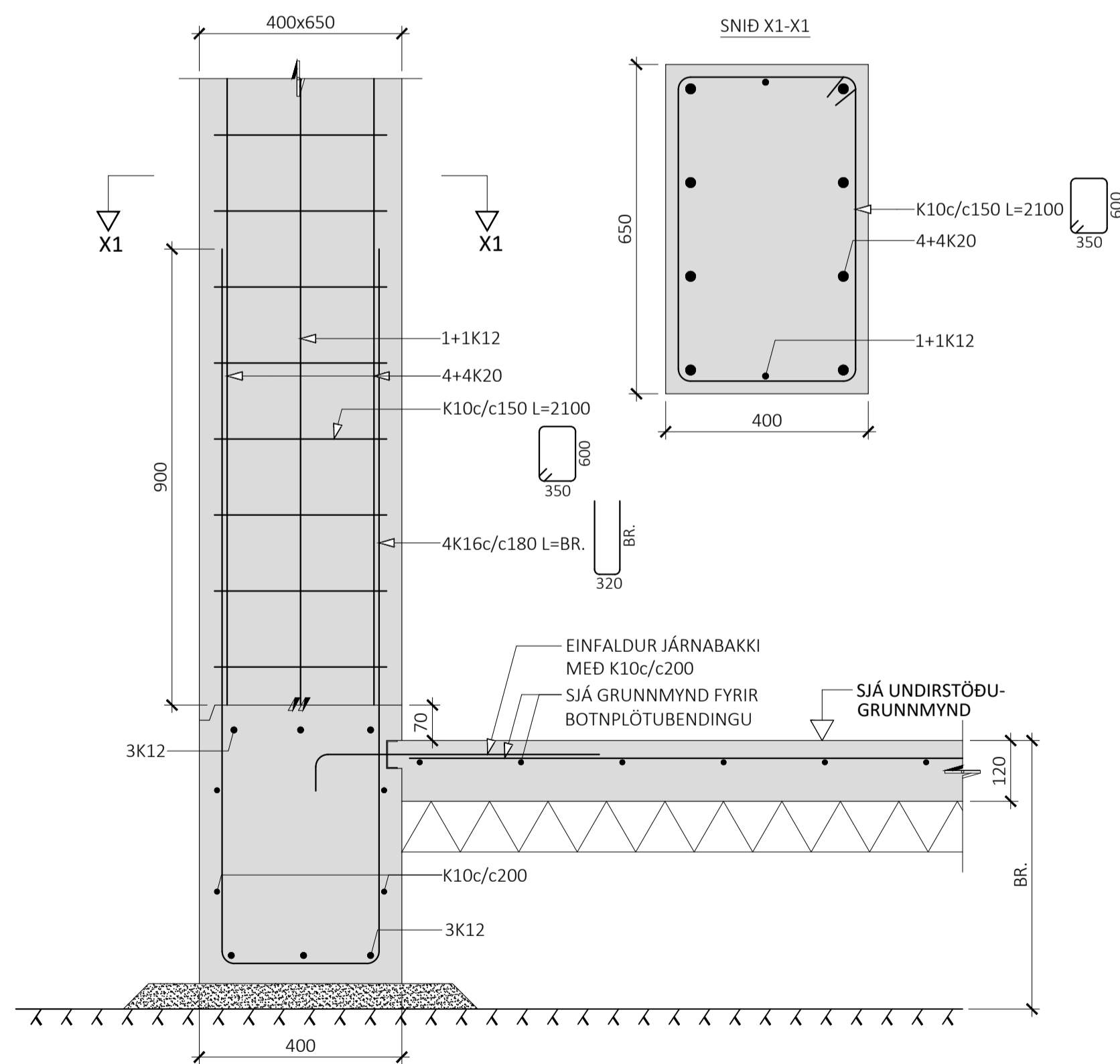

U24
M1:10

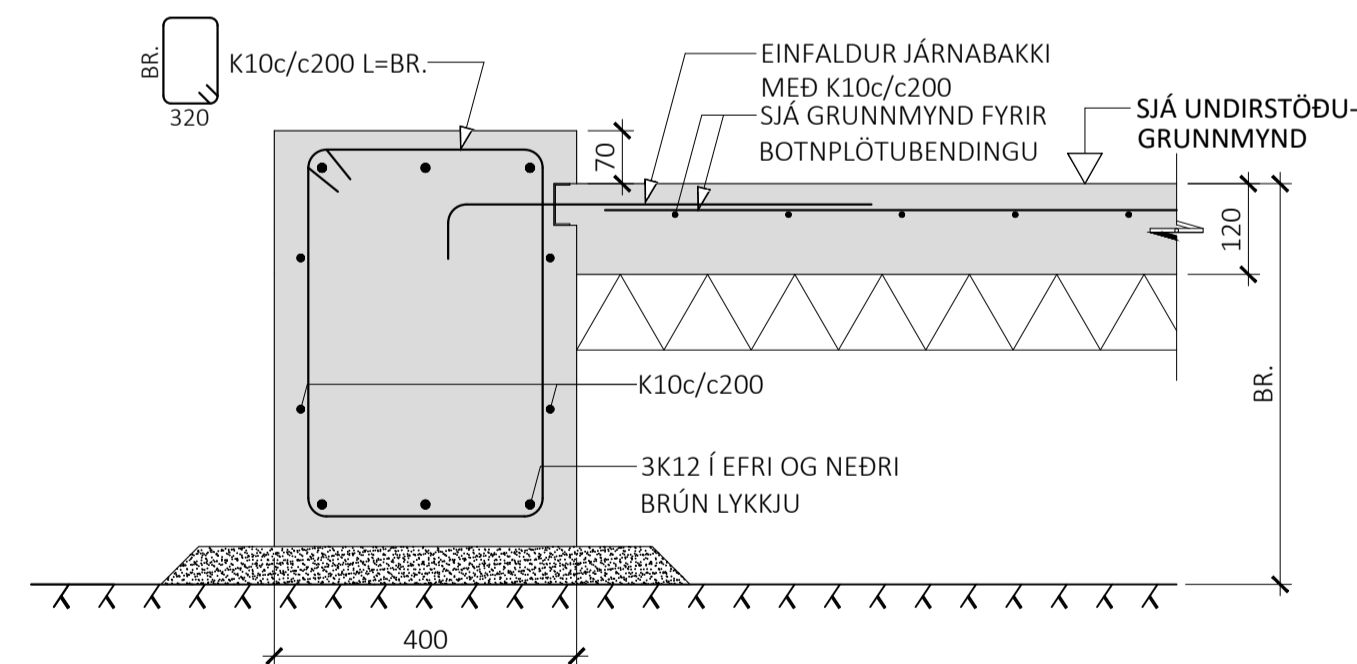

U25
M1:10

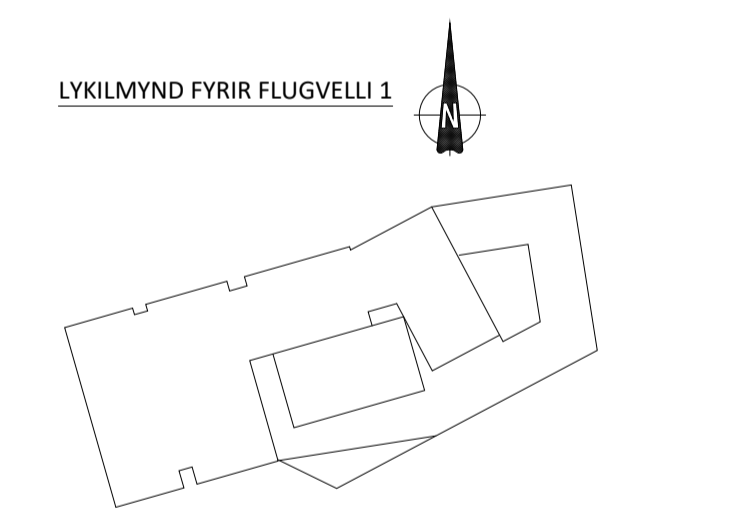
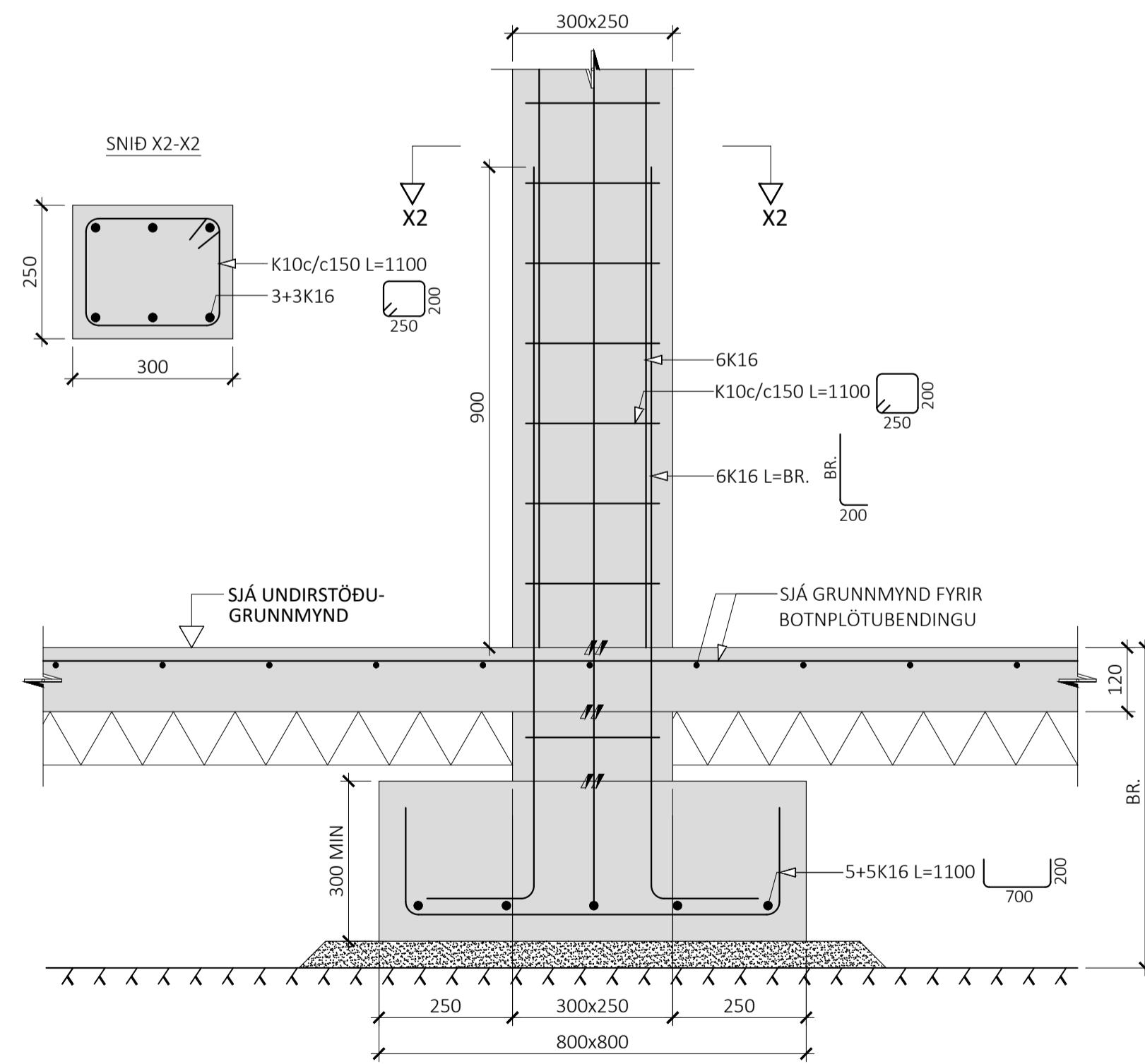

B 03.01.2024 SNÍÐI U21 BREYTT
A 19.10.2022 SNÍÐI U23 BREYTT
ÚTG. DAGS. SKÝRING

FLUGVELLIR 1
HAFNARFIRÐI ICELANDAIR

BURÐARVIRKI UNDIRSTÖÐUR SNÍÐ

SAMPYKKT: KENNITALA:
Hanna Dinsdóttir 070970-4149

DAGS. ÚTGÁFU: 06.10.2022 HÖNNUÐUR: HE
DAGS. BREYTT: 03.01.2024 YFIRFARID AF: GÖS
MÆLIKVARDI: 1:10



HANNA
VERKFRÆÐISTOFA

21024 B-0153 B
VERKNR. NÚMER ÚTG.
SUBURHRAUNI 10 210 GARDABÆR KT. 631216-0480
hannaverk.is hrund@hannaverk.is SÍMI: 771-5252

U38
M1:10

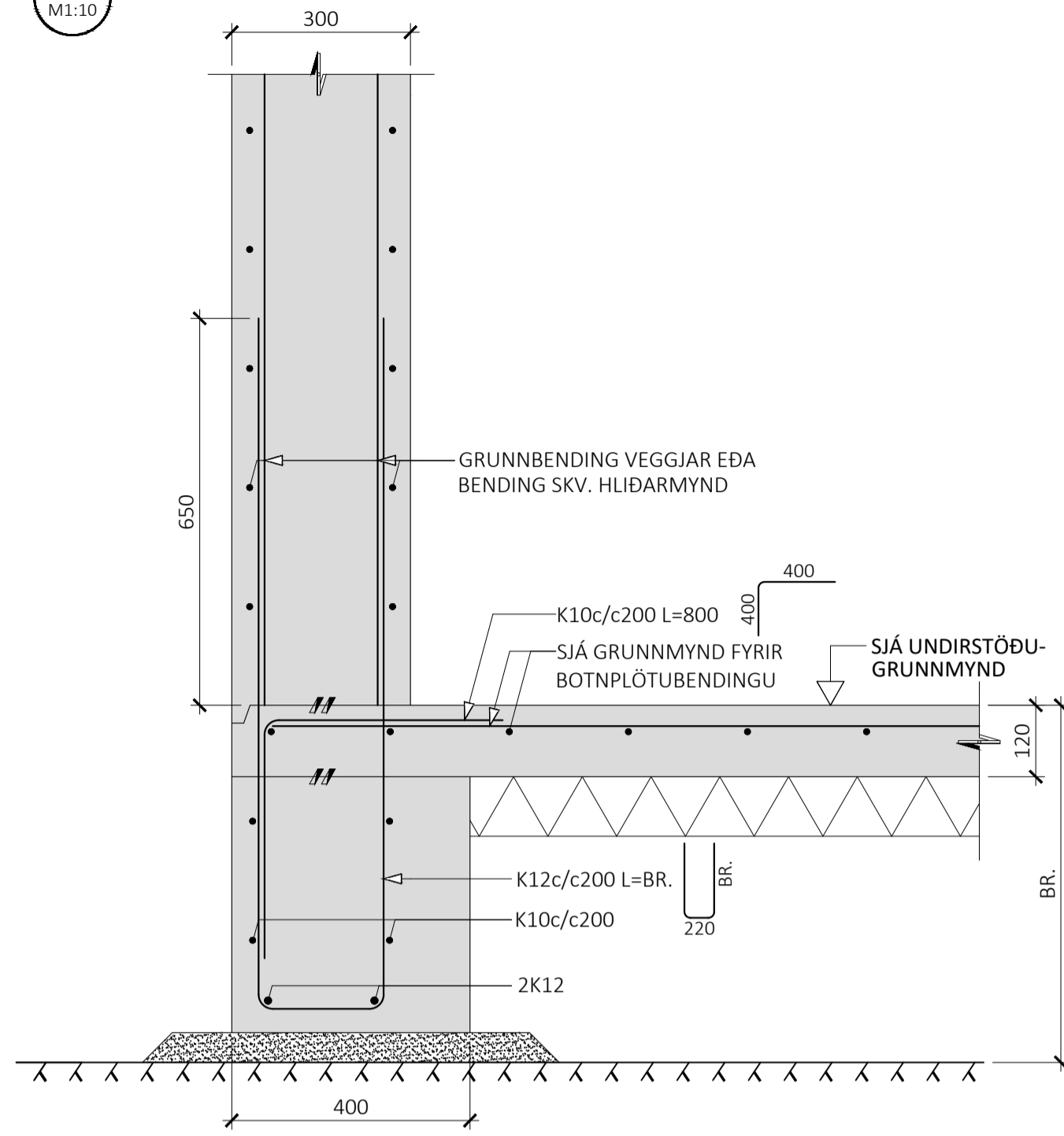

U39
M1:10

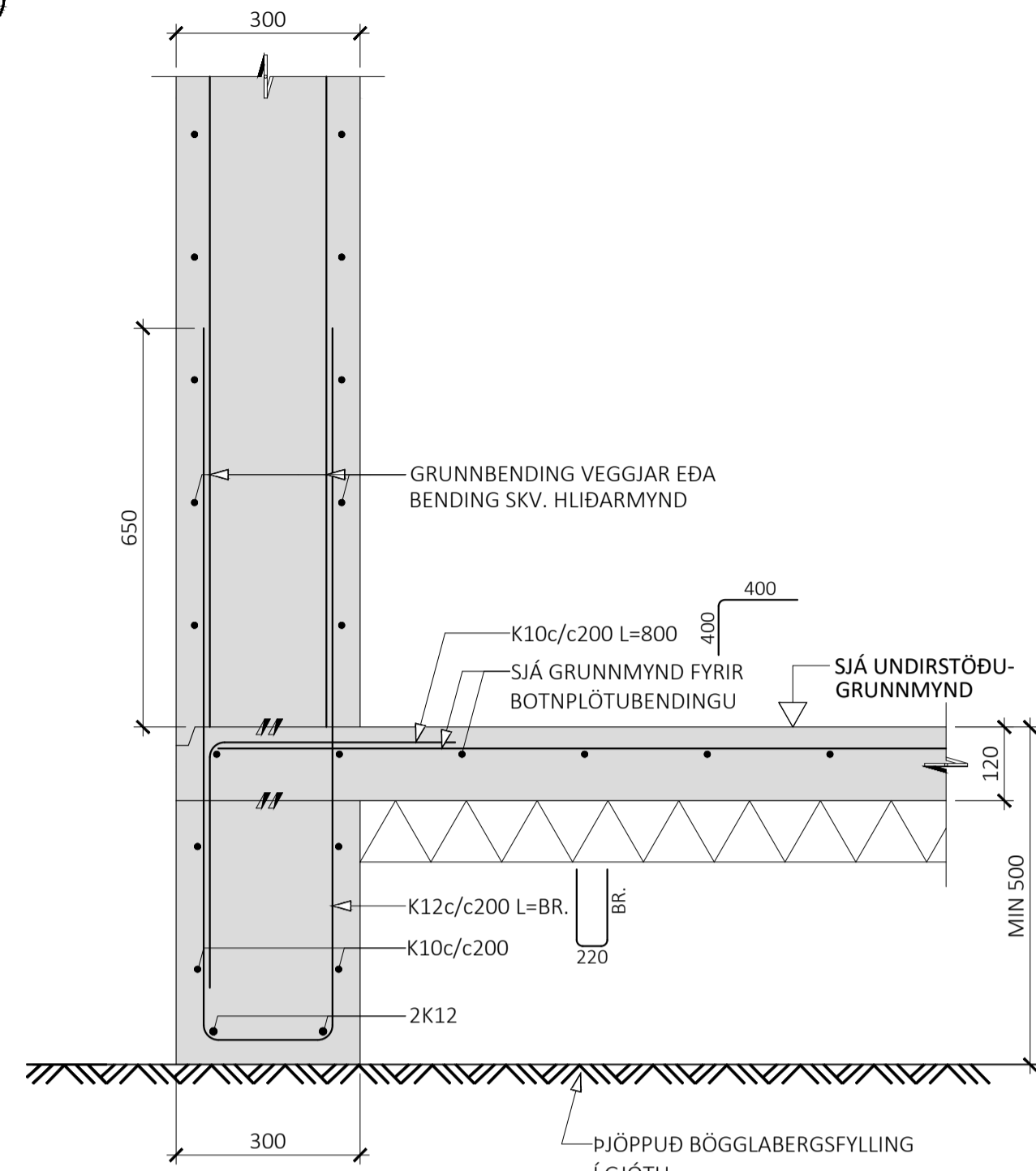



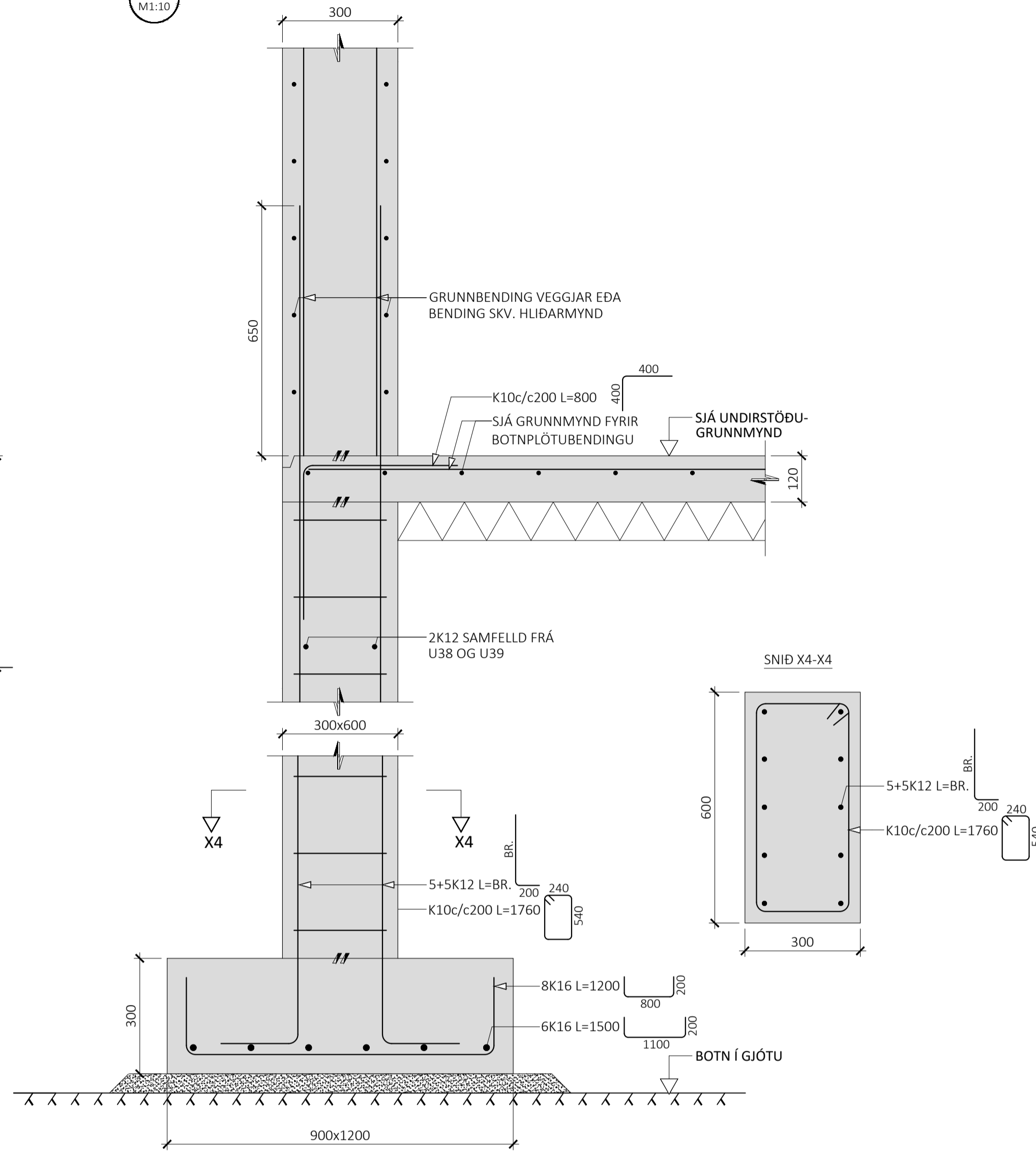

U40
M1:10

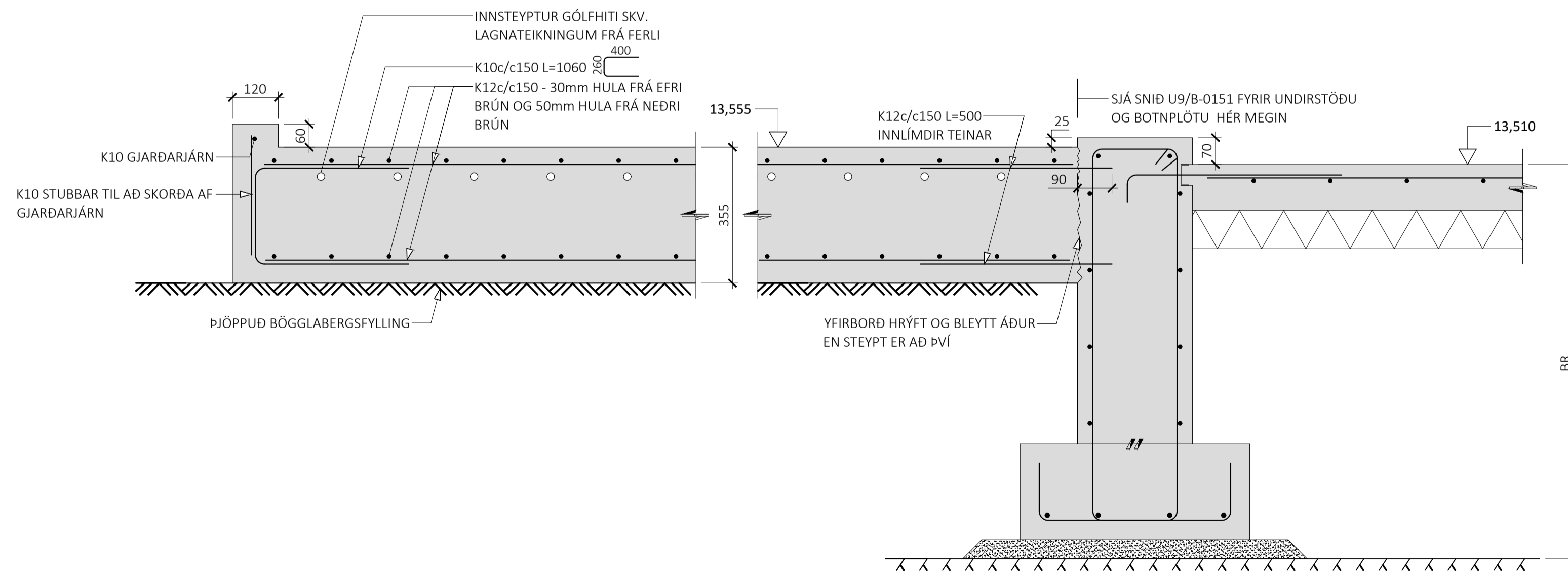

U41
M1:10

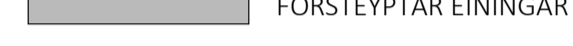

TÁKN:

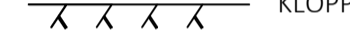
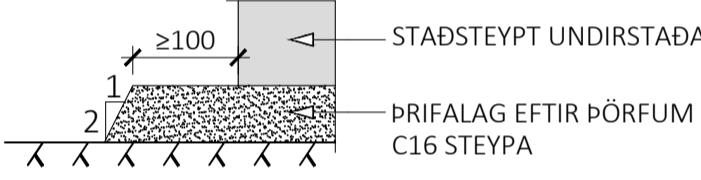
	STADSTEYPA
	FORSTEYPTAR EININGAR
	NÚVERANDI STEYPA
	100mm PÝKK EINANGRUN MED RÚMPYNGD ≥ 24 kg/m ³
	PJAPPADUR BÖGGLABERGSÞÚDI
	KLÖPP
	STADSTEYPT UNDIRSTADA PRIFALAG EFTIR ÞÖRFUM C16 STEYPA

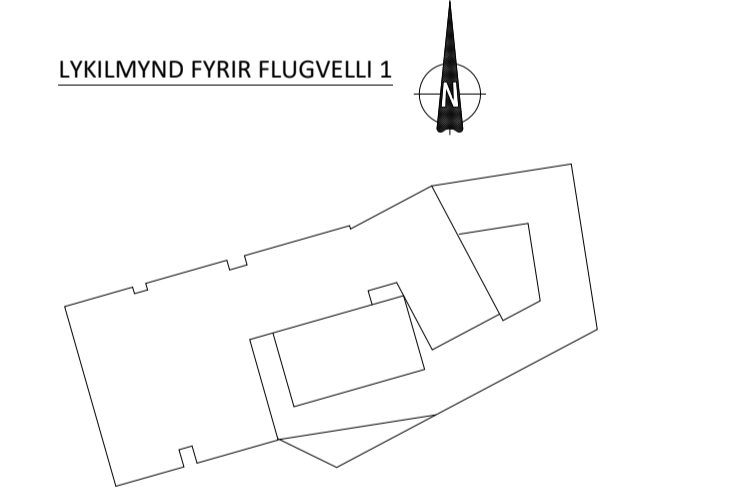

STÁLSTIGI Á MILLI 1. OG 2. HÆÐAR - M1:20

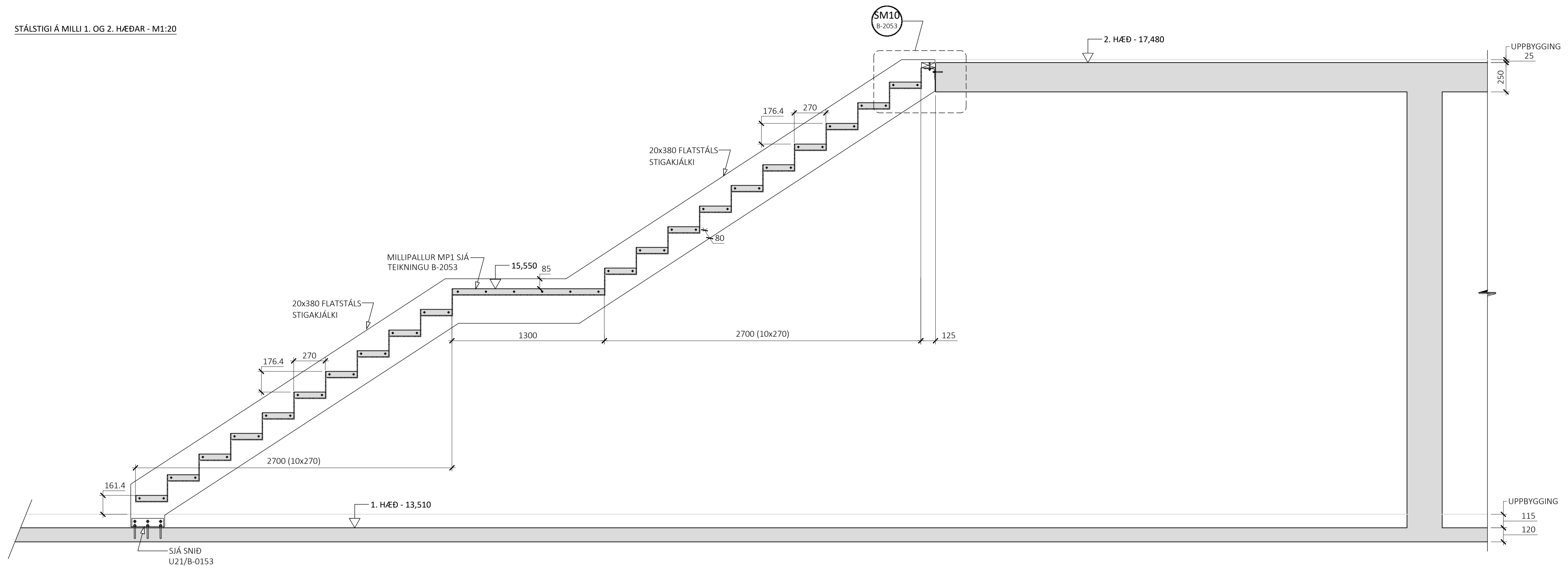

STÁLSTIGI Á MILLI 2. OG 3. HÆÐAR - M1:20

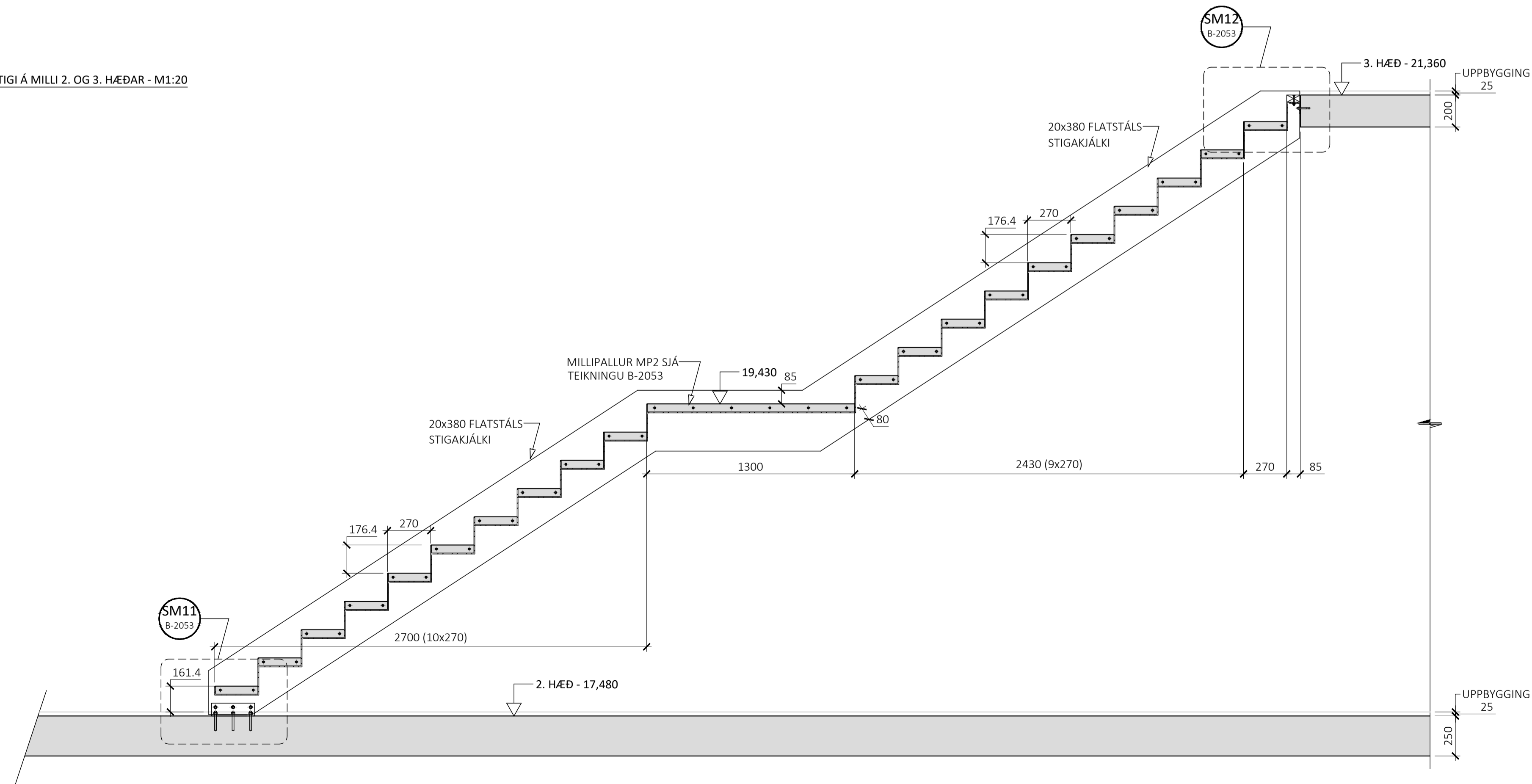

ÁRITUN HÖNNUNARSTJÓRA KT:
BYGGT Á ADALUPPDRATTUM DAGSETTUM: 01.09.2022

- ALMENNAR SKÝRINGAR:
- SJÁ FLEIRI ALMENNAR SKÝRINGAR Á TEIKNINGU B-0000
 - ÖLL MÁL ERU Í MILLIMETRUM, EN KÓTAR OG HNIT ERU Í METRUM

TÁKN:

	STADSTEYPA
	FORSTEYPTAR EININGAR
	NÚVERANDI STEYPA
	NÚVERANDI SAMLOKUEININGAR Á STÁLGRIND

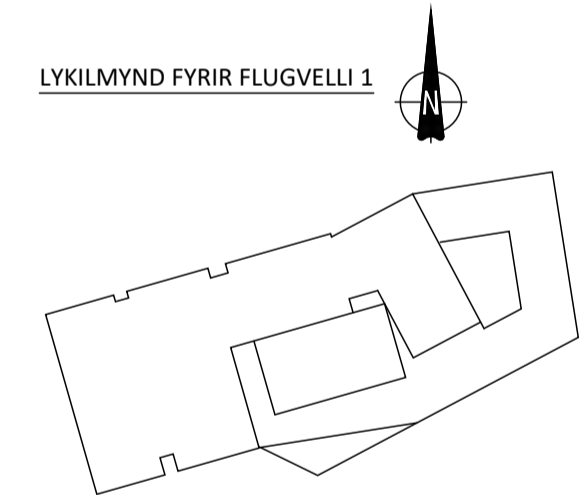

ÚTG. DAGS. SKÝRING

FLUGVELLIR 1
HAFNARFIRDI ICELANDAIR

BURÐARVIRKI
STÁLSTIGAR
SNIÐ

SAMÞYKKT: *Árni Þ. Þorvaldsson* KENNITALA: 070970-4149

DAGS. ÚTGÁFU: 03.01.2024 HÖNNUÐUR: HE
DAGS. BRÉYF: YFIRFARID AF: RD

MELKVARÐI: 1:20

